

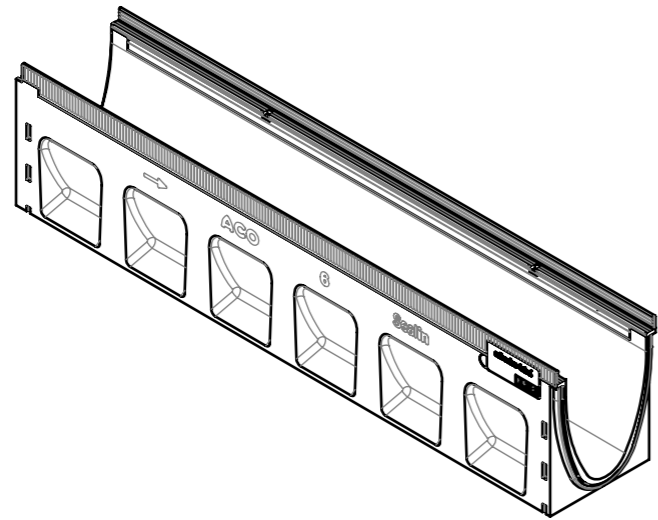
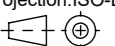

SCALE 1 : 10



material number: 2003718  
local article number: 133306

 ACO Ahlmann SE & Co. KG Am Ahlmannkai 24782 Büdelsdorf www.aco.com	drawing-no.: <b>1031031-M</b>	index: <b>004</b>	documenttype: marketing drw.
	created by: rkumar	reviewed by: smeier	projection:ISO-E 
title: <b>Multiline Seal in</b> <b>Slope Channel V150S 1m 6 with galv. steel rail</b> <b>Gefällerinne V150S 1m 6 mit verzinkter Stahlzarge</b>			<b>serial-released</b>
<small>The reproduction, distribution and utilization of this document as well as the communication of its contents to others without express authorization is prohibited. Offenders will be held liable for the payment of damages. All rights reserved in the event of the grant of a patent, utility model or design. Observe copyright by ISO 16016</small>			release date: <b>17.02.2023</b>
			sheet: <b>1/1</b>