

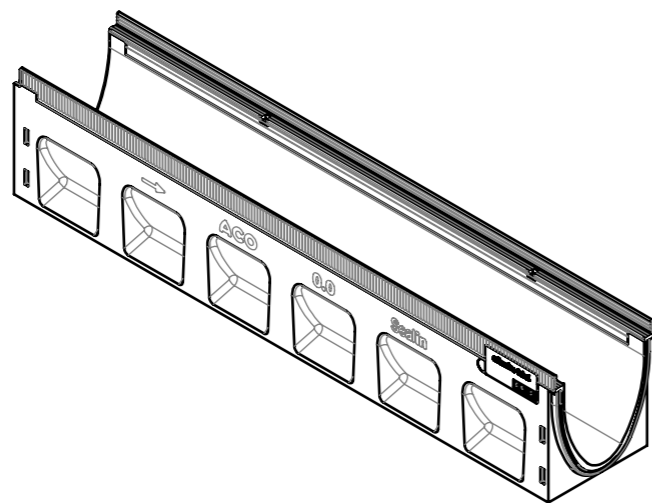
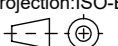

SCALE 1 : 10



material number: 2003730
local article number: 133330

 ACO Ahlmann SE & Co. KG Am Ahlmannkai 24782 Büdelsdorf www.aco.com	drawing-no.: 1030852-M	index: 004	documenttype: marketing drw.
	created by: rkumar	reviewed by: smeier	projection: ISO-E 
title: Multiline Seal in Channel V150S 1m 0.0 with galv. steel rail Rinne V150S 1m 0.0 mit verzinkter Stahlzarge			serial-released
<small>The reproduction, distribution and utilization of this document as well as the communication of its contents to others without express authorization is prohibited. Offenders will be held liable for the payment of damages. All rights reserved in the event of the grant of a patent, utility model or design. Observe copyright by ISO 16016</small>			release date: 07.02.2023
			sheet: 1/1