

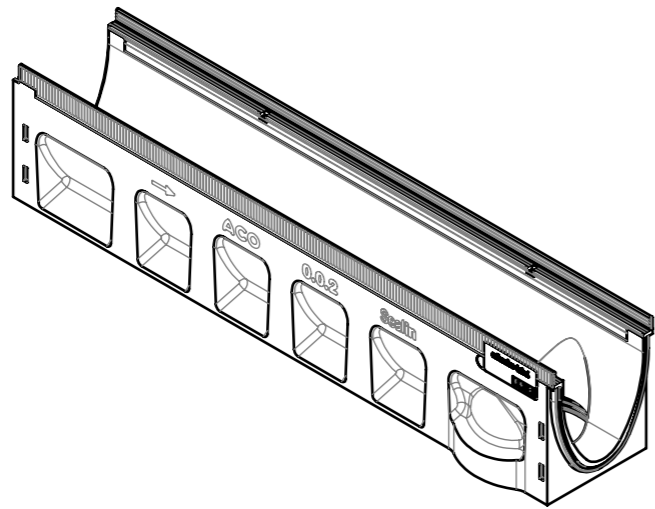
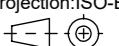

SCALE 1 : 10



material number: 2003733
local article number: 133334

 ACO Ahlmann SE & Co. KG Am Ahlmannkai 24782 Büdelsdorf www.aco.com	drawing-no.: 1033535-M	index: 004	documenttype: marketing drw.
	created by: rkumar	reviewed by: smeier	projection: ISO-E 
title: Multiline Seal in Channel V150S 1m LLD 0.0.2 with galv. steel rail Rinne V150S 1m LLD 0.0.2 mit verzinkter Stahlzarge			serial-released
The reproduction, distribution and utilization of this document as well as the communication of its contents to others without express authorization is prohibited. Offenders will be held liable for the payment of damages. All rights reserved in the event of the grant of a patent, utility model or design. Observe copyright by ISO 16016			release date: 07.02.2023
			sheet: 1/1