

1 2 3 4 5 6 7 8

A

B

C

D

E

F

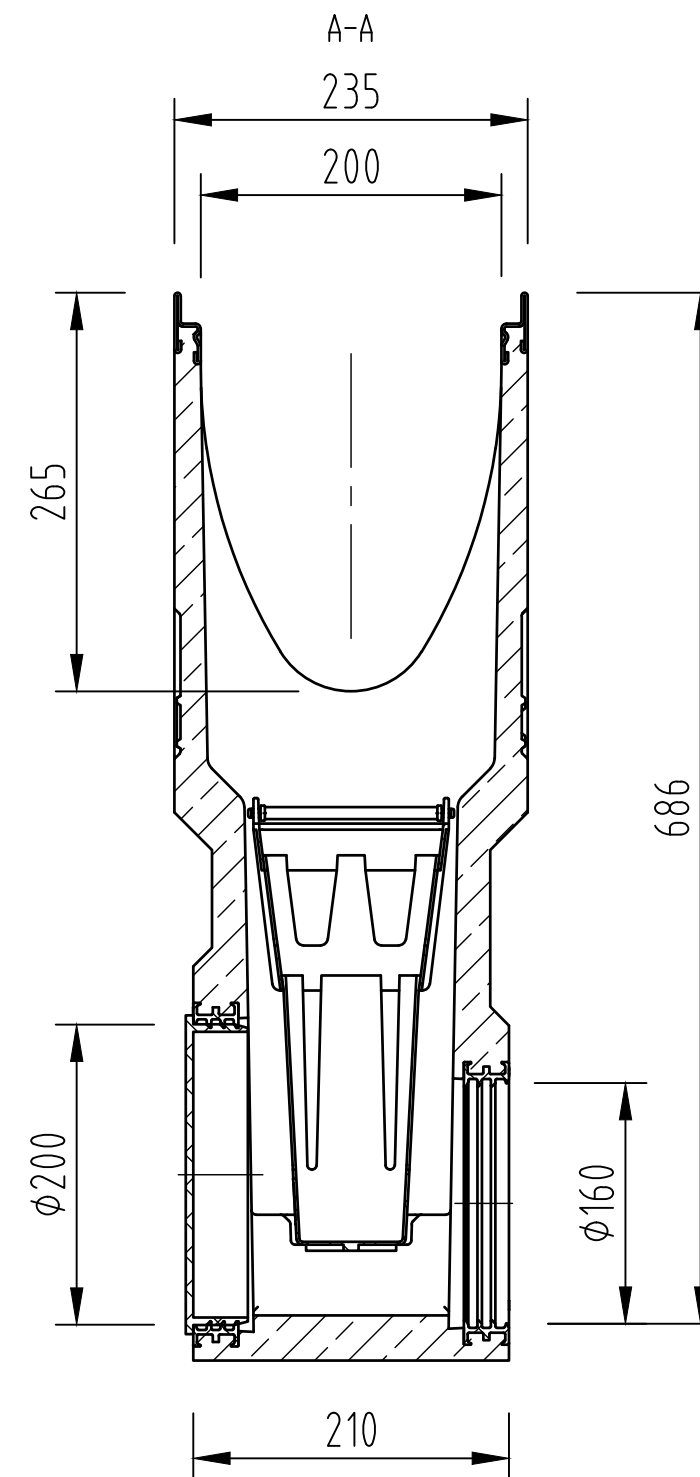
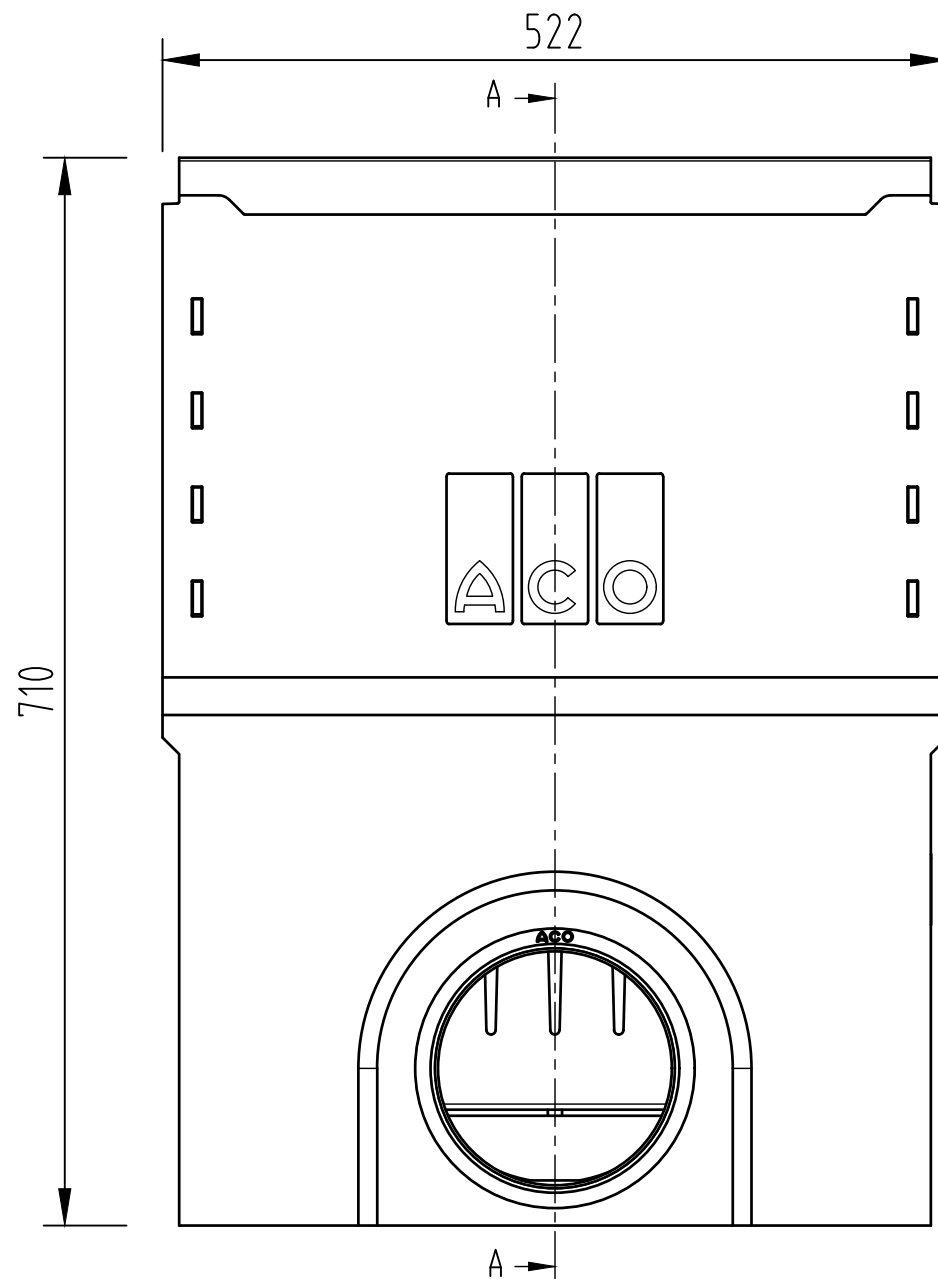
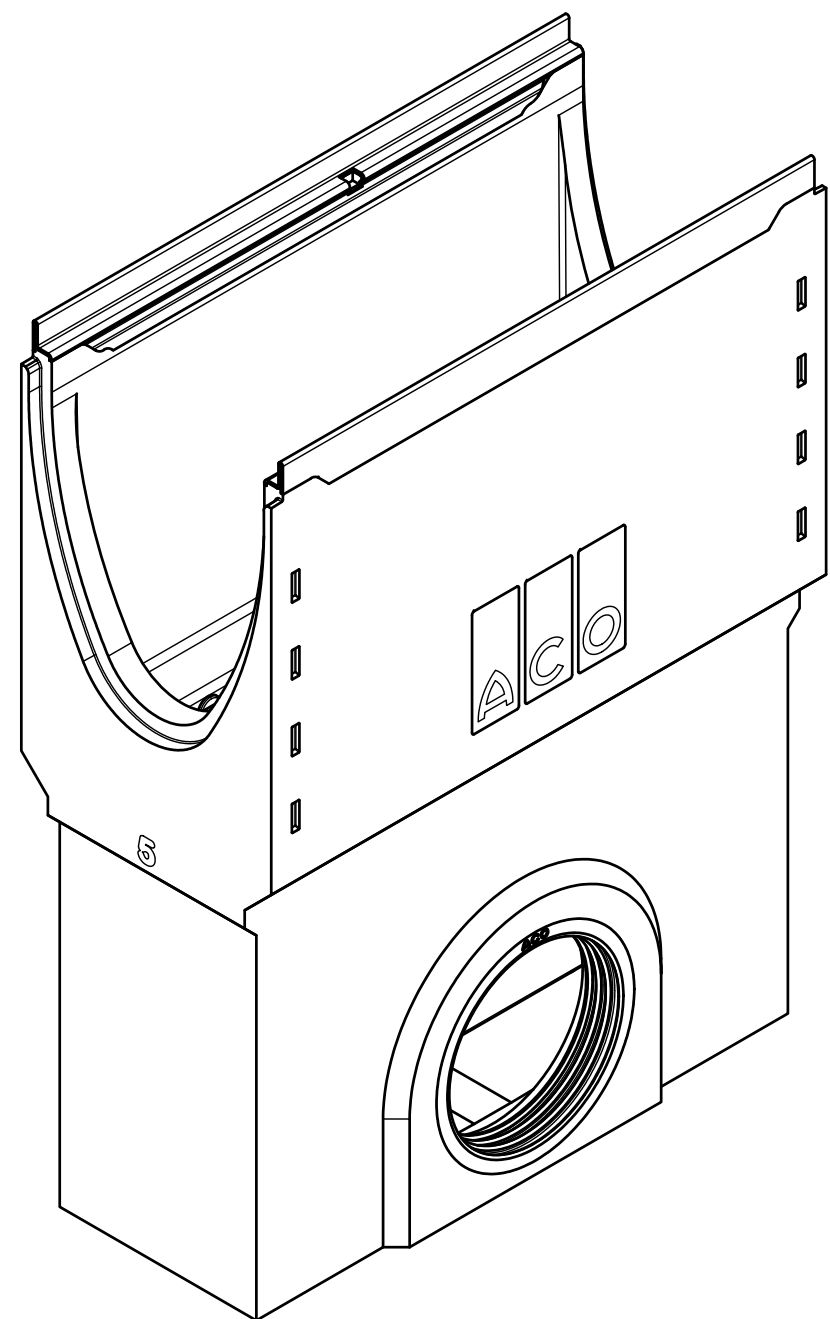

local article number: 133792

ACO Tiefbau Vertrieb GmbH 24755 Rendsburg, Postfach 320 Tel. 04331 / 354-500 FAX 04331/ 354-358 www.aco-tiefbau.de	drawing-no: 1042747-M	index:	documenttype: marketing drw.
	created by:	reviewed by:	projection:ISO-E scale: 1:1
title: Multiline Seal in Sump unit V200E DN160-DN200 5 with stainless steel rail Einlaufkasten V200E DN160-DN200 5 mit Edelstahlzarge			release date:
The reproduction, distribution and utilization of this document as well as the communication of its contents to others without express authorization is prohibited. Offenders will be held liable for the payment of damages. All rights reserved in the event of the grant of a patent, utility model or design. Observe copyright by ISO 16016			sheet: 1/1

1 2 3 4 5 6 7 8