

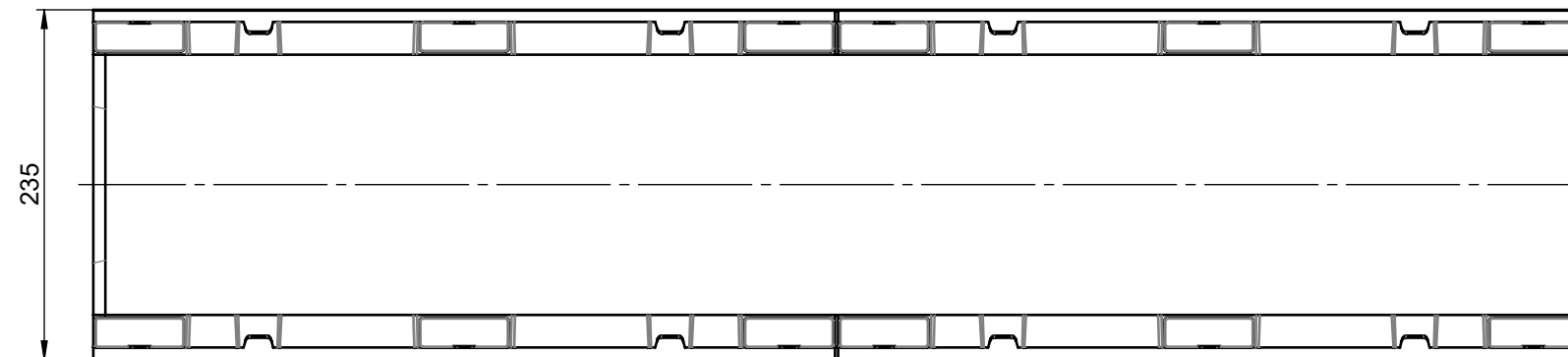

SCALE 1 : 10

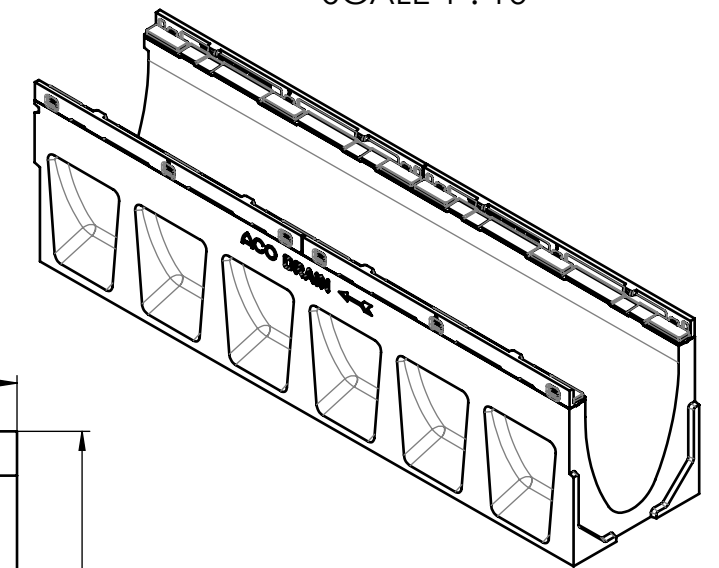
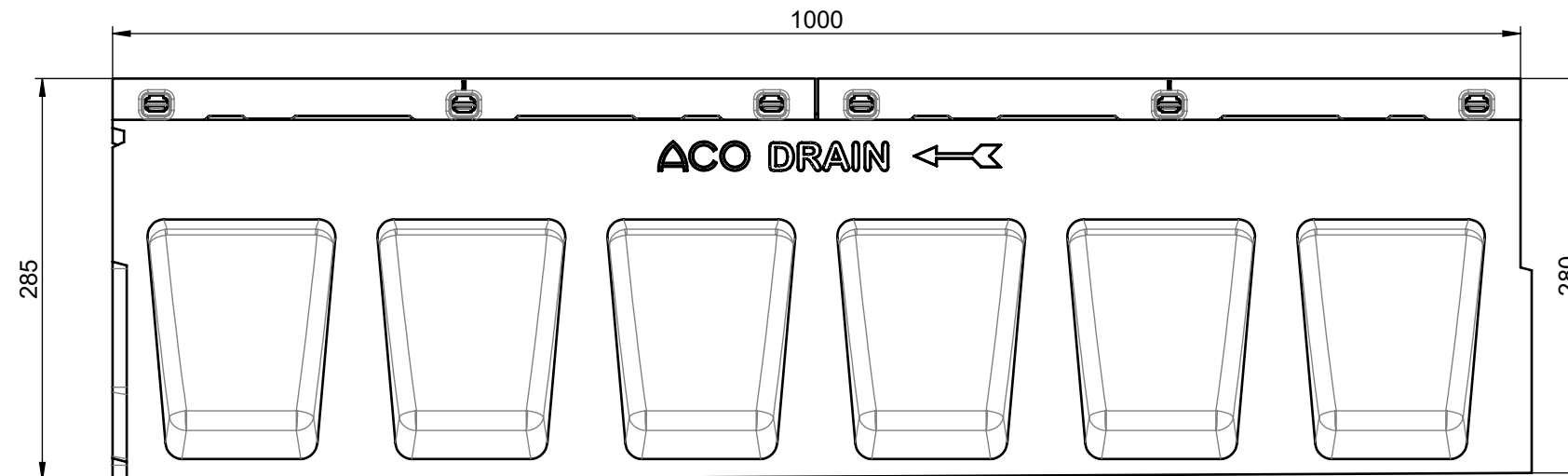
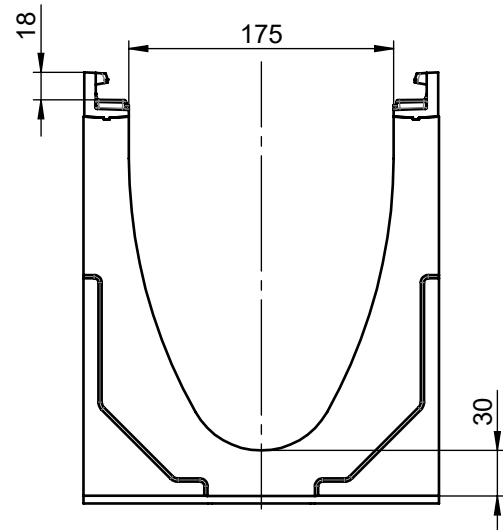
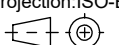

material number: 2002018
local article number: 11667

 ACO Ahlmann SE & Co. KG Am Ahlmannkai 24782 Büdelsdorf www.aco.com	drawing-no.: 1162145-M	index: 001	documenttype: marketing drw.	
	created by: rshetty	reviewed by: rshetty	projection: ISO-E 	scale: 1:5
title: ACO Powerdrain V175P Slope Channel 1m 7 with CI rail V175P Gefaellerinne 1m 7 mit Gusszarge			serial-released	
The reproduction, distribution and utilization of this document as well as the communication of its contents to others without express authorization is prohibited. Offenders will be held liable for the payment of damages. All rights reserved in the event of the grant of a patent, utility model or design. Observe copyright by ISO 16016			release date: 26.09.2022	sheet: 1/1