

# Kombistirnwand für Rinnenanfang und -ende

Art.-Nr. 11695

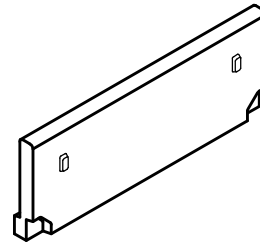
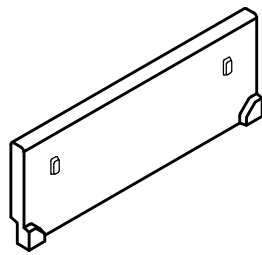
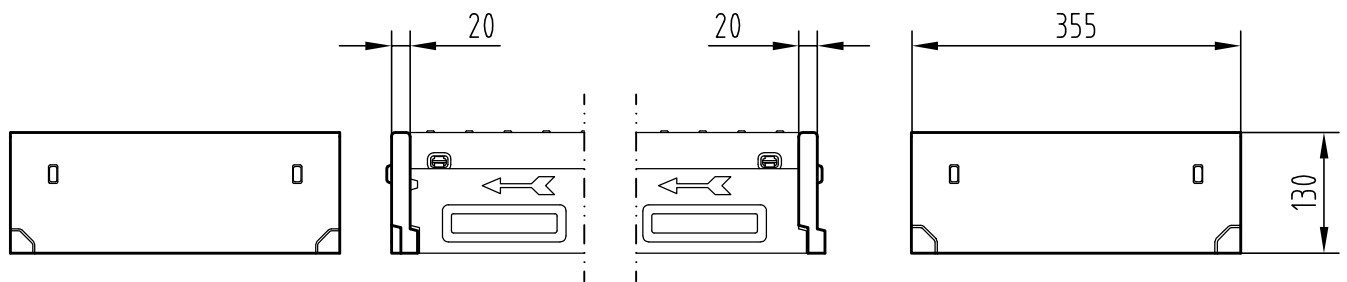

# Stirnwand DN/OD 75 für Rinnenende

Art.-Nr. 11697

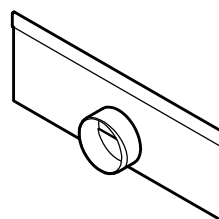
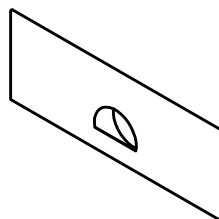
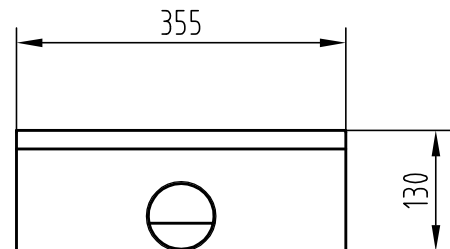
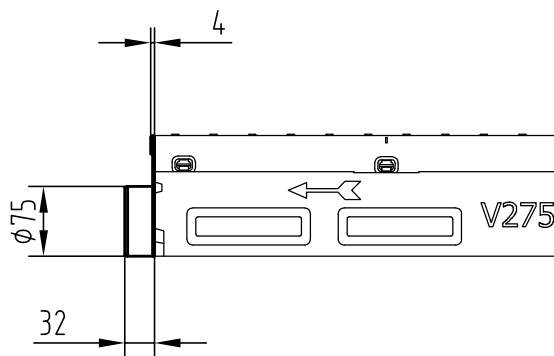

Stahl verzinkt und  
KTL beschichtet

Benennung:  
ACO DRAIN V 275 P Flachrinne mit Kombistirnwand  
und Stirnwand mit Stützen DN/OD 75  
Art.-Nr. 11695,11697

	Datum	Name
Gez.	16.04.2009	debeling
Upd.	17.04.2009	debeling
Norm		



**ACO Tiefbau**

ACO Tiefbau Vertrieb GmbH  
24755 Rendsburg, Postfach 320  
Tel. 04331/ 354-500  
FAX 04331/ 354-350  
www.aco-tiefbau.de

Zeichnung-Nr.  
G1-M01-1258-3

Technische Änderungen vorbehalten

Schutzvermerk gemäß DIN 34

Ers. für: