

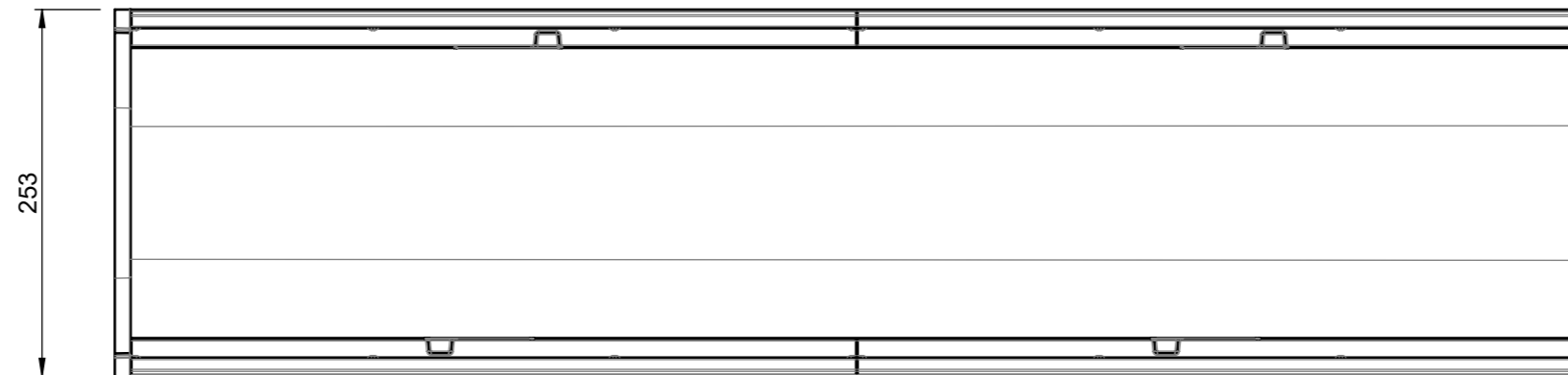

SCALE 1 : 10

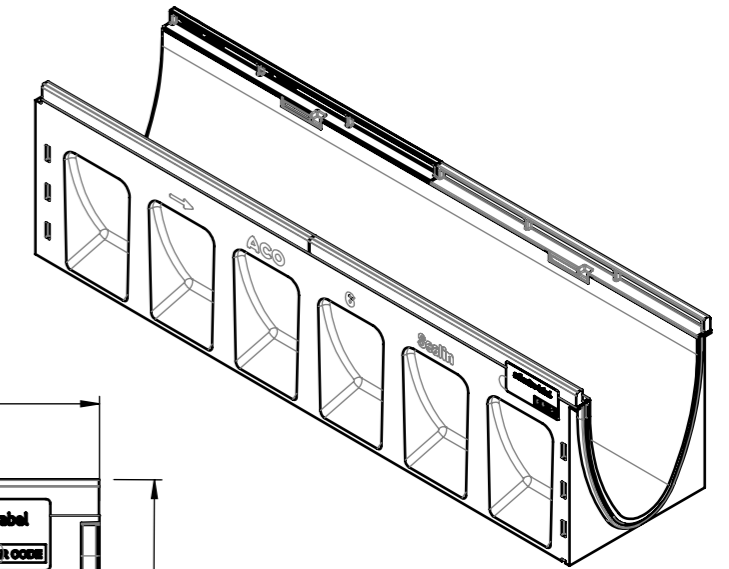
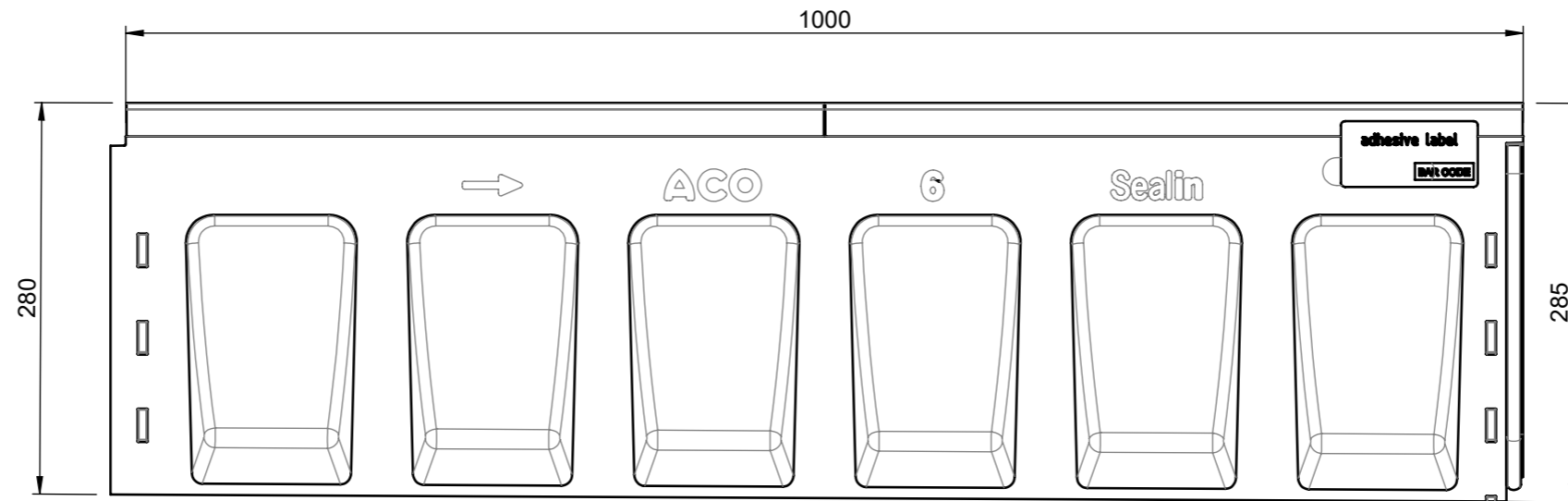
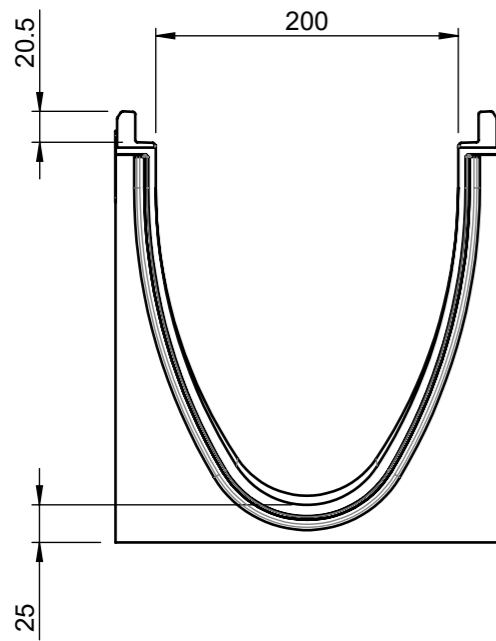
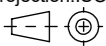

material number: 3000752
local article number: 152406

 ACO Ahlmann SE & Co. KG Am Ahlmannkai 24782 Büdelsdorf www.aco.com	drawing-no.: 1080596-M	index: 004	documenttype: marketing drw.
	created by: kmurthy	reviewed by: kmurthy	projection: ISO-E  scale: 1:5
title: PowerDrain Slope Channel PowerDrain Seal in V200G 6 Gefällerinne PowerDrain Seal in V200G 6			serial-released
The reproduction, distribution and utilization of this document as well as the communication of its contents to others without express authorization is prohibited. Offenders will be held liable for the payment of damages. All rights reserved in the event of the grant of a patent, utility model or design. Observe copyright by ISO 16016			release date: 15.02.2022
			sheet: 1/1